

## Eiermann 2

### Table frame

Idea originated from Egon Eiermann's collaborators, 1965

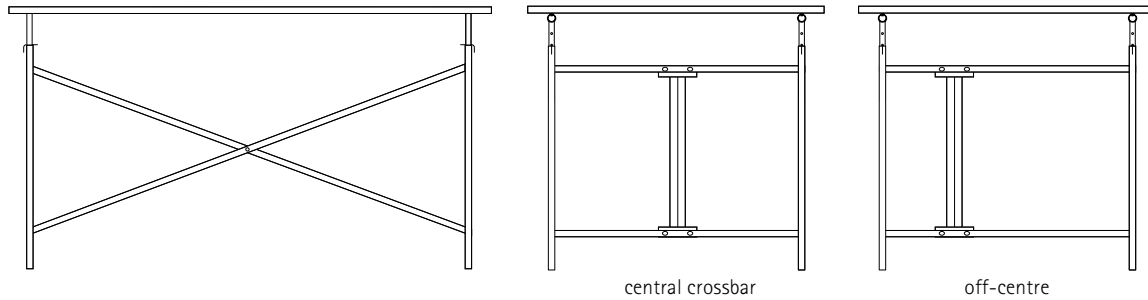

width mm	depth mm	height mm	colour	chrome- plated	stainless steel
			black RAL 9005 white RAL 9010 silver RAL 9006 colourless		
800	660	660	x	x	
1000	660	660	x	x	x
1000	780	660	x	x	x
1350	660	660	x	x	x
1350	780	660	x	x	x

When ordering, please state desired type of crossbars: central (for sitting up straight) or off-centre (for sitting at an angle with outstretched legs). Stainless version with central crossbar only.

height adjustment rods, 35 mm hole grid (1 set)	short (standard) length = 165 mm, 2 hole	long length = 335 mm, 5 holes	with mounting lug	rubber caps 1 set
colour	x	x	x	x
chrome-plated	x	x	x	
stainless steel	x	x	x	

For a table height of 720 or 750 mm you will need height adjustment rods. With the short ones you achieve about 750 mm in the second hole. The long rods with 5 holes enable further heights and sit a bit more stable in the frame tubes.

For uneven floors we recommend levelling feet. This will give you a table height of approx. 720 mm. With additional extensions in the first hole, you will achieve a table height of approx. 750 mm.

We strongly recommend using rubber caps between frame and tabletop to prevent the tabletop from sliding.

The top for the table frame 1350 may bend slightly under the continuous load of monitors/PCs. Here, especially for the contract sector, we recommend using the respective support (p. 7).

**This table frame was not designed by Egon Eiermann and it does not comply with his idea of form and detail.** We recommend the original version Eiermann 1 for desks and the Eiermann 2 for dining or conference tables with central crossbar.

Frames (but not the tabletops) can be shipped by standard parcel service.

**Eiermann 2  
Accessories**

All prices per set

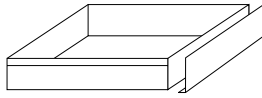

drawer, MDF melamine, white

small 344 × 344 × 45 mm (inside)	x
surcharge front panel aluminium in frame colours	x
surcharge front panel chromed	x

big 460 × 344 × 45 mm (inside)	x
surcharge front panel aluminium in frame colours	x
surcharge front panel chromed	x

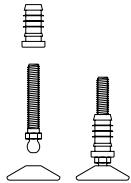

levelling feet (set of 4)  
for uneven floors  
to align table heights  
height 13 to 33 mm

x

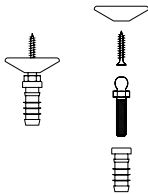

top fixing set  
for steeply inclined tops  
height + 20 mm

x

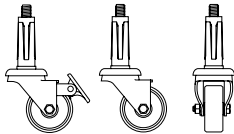

castors  
(set of 4, 2 with brakes)  
height + 70 mm

rubber castors	x
rubber castors for heavy use	x
castors for wooden floors (PU tread)	x

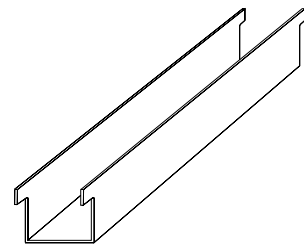

cable channel  
1000 × 100 × 60 mm  
1350 × 100 × 60 mm

all tables  
frame colours

Stainless steel polished  
or lacquered  
'chrome-look'

x	x
x	x

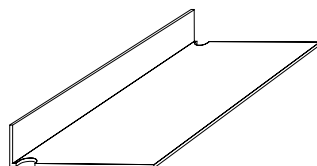

CPU-holder  
660 × 220 × 85 mm  
780 × 220 × 85 mm

x	x
x	x

For bending glass	x	x
or table tops	x	



glass support 1350	x	x
--------------------	---	---

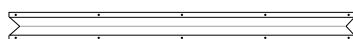

table top support, white (trapezoidal sheet metal)	x	
---	---	--