

# U-LIFT

## ERGONOMICS AND DESIGN – THINK COMPACT

U-LIFT gives you enough space to work, concentrate and keep organised – and all in a small space. This small and practical desk not only provides storage space for the most important documents, it also offers an elegant answer to the dreaded “cable spaghetti”.

Furthermore, U-LIFT will meet your ergonomic expectations because its height can be adjusted electronically from 68 to 117 cm. This makes it possible to quickly switch between sitting and standing as needed during the day.

**Design: Christian Horner**



**bene**

INSPIRING OFFICES. SINCE 1790.

## PRODUCT DESCRIPTION

- ① **Tabletop:** compact board 13 mm, 19 mm chipboard with 2 mm mono-edge or 20 mm chipboard with Fenix laminate with 1 mm edge
- ② **Power supply unit**
- ③ **Manual switch**
- ④ **Frame**
- ⑤ **Column:** steel
- ⑥ **Base plate:** steel
- ⑦ **Spiral cable:** black

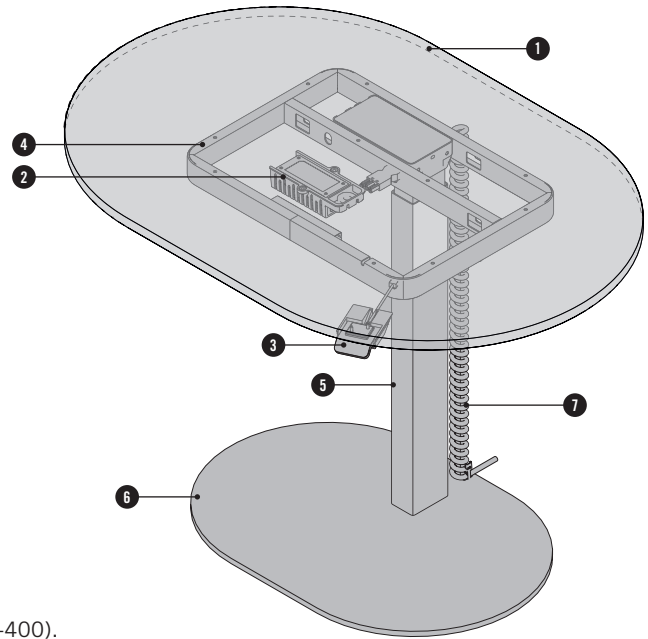

The warranty period is five years.  
 Covered by Bene's warranty conditions (Bene product warranty DB-ZFP-400).

## OVERVIEW AND DIMENSIONS

<p><b>TABLETOP</b></p> <p style="text-align: center;">1.000</p> <div style="text-align: center;"> <p>670</p> </div>	<p><b>COLUMNS</b>                  powder coated steel profile pipe, rectangular: 80x50 mm</p> <p><b>BASE PLATE</b>                  powder coated flat steel 10 mm                  colours: black, white, or aluminium</p>
<p><b>HEIGHT ADJUSTMENT</b></p> <div style="display: flex; align-items: center; justify-content: space-around;"> <div style="text-align: center;"> <p>min. 680</p> </div> <div style="text-align: center;"> <p>max. 1.170</p> </div> </div>	<p><b>Maximum load 30 kg</b>                  (all mounted and installed parts/loads must be included in the calculation)</p> <p><b>Two-part telescopic rectangular column</b></p> <ul style="list-style-type: none"> <li>• Stroke length 495 mm</li> <li>• Lifting capacity 500 N</li> <li>• Control system integrated into the column; manual switch is connected directly to the column</li> </ul>

**Dimensions in mm**

## PRODUCT DESCRIPTION

### POWER SUPPLY UNIT SMPS006

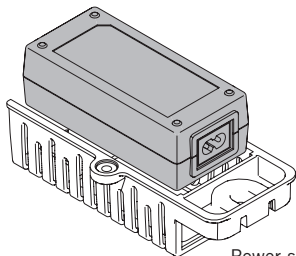

Power supply unit holder

#### Type

- Power supply input 100V AC to 240V AC, 50 Hz/60 Hz
- Maximum on-time 2 min. on, 18 min. off
- Protection category II
- Noise ~46 dB
- Upward lift speed 38 mm/s

#### Reference values for power consumption

	Load	Power consumption
· Stand-by		<0.1 watts
· Upward lift	30 kg	175 watts

### HEIGHT ADJUSTMENT WITH MANUAL SWITCH

There are three different types of manual switch.

#### MANUAL SWITCH EASY

**Dimension:** W: 60 mm, H: 15,8 mm

**Colour:** Anthracite grey

**Functions:** up/down function, operation via buttons



#### MANUAL SWITCH BASIC WITH SENSOR

**Dimension:** W: 82 mm, H: 28,8 mm

**Colour:** Black

**Functions:** up/down function, intuitively operated element, with integrated collision protection sensor



#### MANUAL SWITCH PREMIUM WITH SENSOR

**Dimension:** W: 82 mm, H: 28,8 mm

**Colour:** Black

**Functions:** up/down function, intuitively operated element, with integrated collision protection sensor, graphic display. 4 memory positions, key lock, upper and lower limit of table height



#### Intuitive operation

The manual switches (BASIC WITH SENSOR and PREMIUM WITH SENSOR) are operated via a tilt function instead of buttons so that direct visual contact with the hand control is not necessary when adjusting the height of the table.

## OPTIONS

### SCREENING ELEMENT

You can install the screening element on the left or right side. It also provides an elegant way to route charging cables and the like below the table and even makes an ideal storage place for a docking station.

- Can be installed on the left or right
- Colours: Powder-coated steel in SZ black, WI white or AL aluminium coloured
- Dimensions: Width 376,5 mm, depth 376,5 mm, height 180 mm

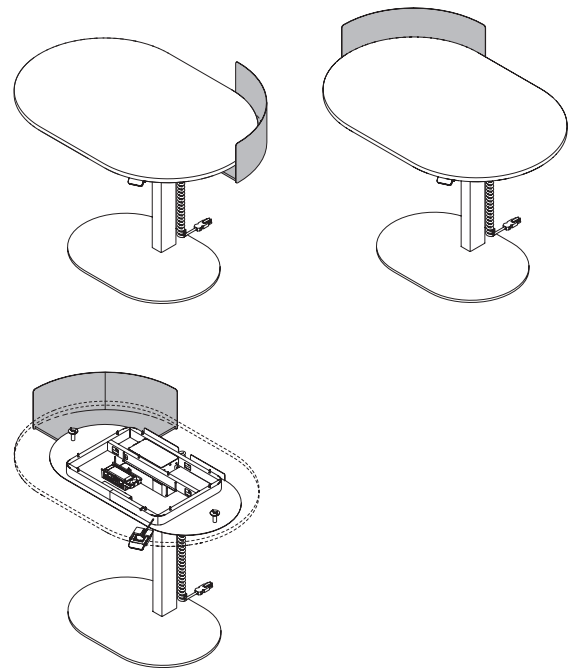

---

### CABLE MANAGEMENT

With the U-LIFT, cables are managed in a particularly attractive manner, by means of a spiral cable (including 2 m starter cable) that supplies the column with power. This is included within the scope of delivery. It is also possible to order a 3 m or 5 m starter cable.

If desired, the table can be made ready to hold a connection plug board underneath, versions: 4x power socket or 3x power socket, 2x USB chargers (A+C).

These preparations also include a cover that conceals the electronic components and creates additional space for excess cable lengths on both the left and right. Colours: SZ black, WI white or AL aluminium coloured

Connection plug board must be ordered separately.  
Connection plug boards → Price list for cable and media management

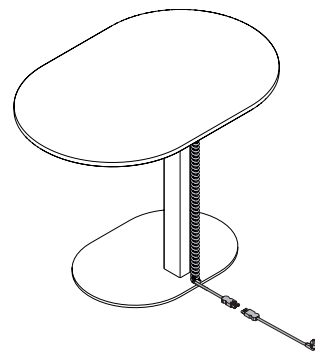

Spiral cable with 2 m starter cable

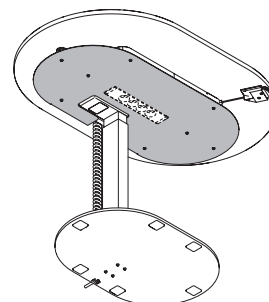

Preparation for connection plug board under the table

## MELAMINE

### MELAMINE GROUP 1: Basic colours

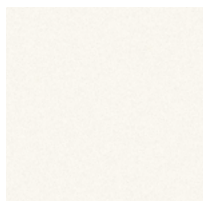

MW white

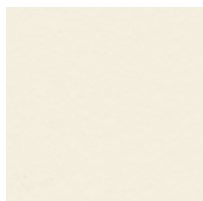

MQ office white

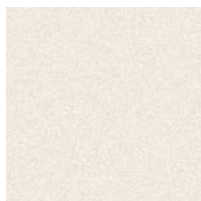

MC canvas

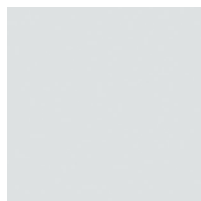

MP platinum



MA aluminium

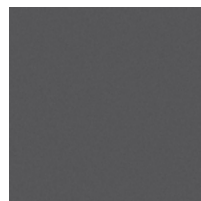

MS slate

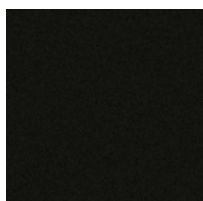

MB basalt

### MELAMINE GROUP 2: Additional basic colours



MH stone grey

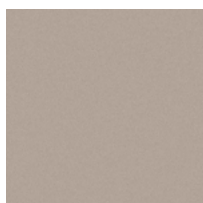

TM clay

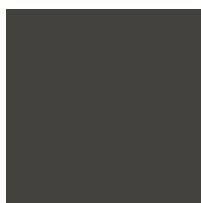

MD urban grey

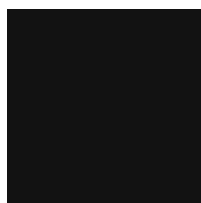

MGS graphite black

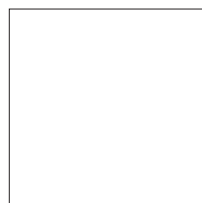

MSW snow white

### MELAMINE GROUP 2: Decor colours

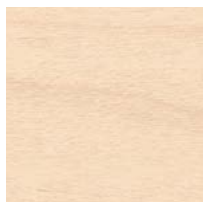

AR maple



EZ oak vicenza



BH beech light



NG walnut grey

### MELAMINE GROUP 3: Accent colours



MPZ pistachio



MHR light rose

### MELAMINE GROUP 3: Decor colours, wooden texture



CO coco texture

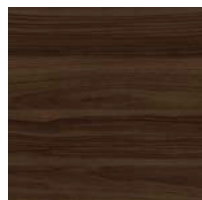

MNP walnut pavia

## COLOURS & MATERIALS

### VENEER: Maple



AK canad. maple

### VENEER: Beech



BG beech, grey

### VENEER: Oak



EY oak, silt

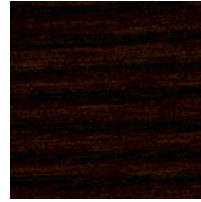

ER oak, amaretto

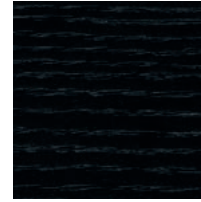

EV oak, volcano



EG oak grey

### VENEER: Chestnut



KD chestnut natural



KP chestnut brown



KQ chestnut grey

### VENEER: Walnut



NF americ. walnut



NR walnut, sienna



NB walnut, umbra

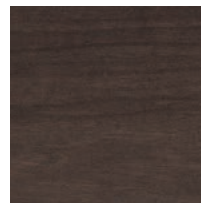

NA wal., anthracite

### METAL SURFACE POWDER-COATED

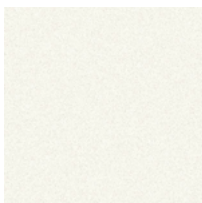

WI white

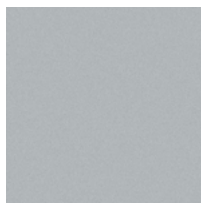

AL aluminium



SZ black

### FENIX

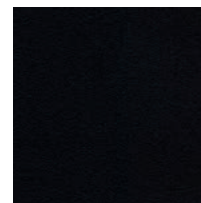

black

All veneers and varnished surfaces can also be selected in a matt version.